

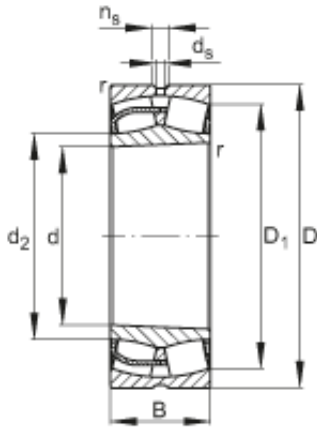

DRIVESHAFT AND BEARINGS MANUFACTURE C...



190 mm x 400 mm x 132 mm FAG 22338-E1-K spherical roller bearings

Bearing No. 22338-E1-K

22338-E1-K Bearing 2D drawings and 3D CAD models

Size	190x400x132 mm
Bore Diameter	190 mm
Outer Diameter	400 mm
Width	132 mm
d	190 mm
D	400 mm
B	132 mm
D ₁	338,1 mm
D _{a max}	380 mm
d ₂	236,8 mm
d _{a min}	210 mm
d _s	12,5 mm
n _s	23,5 mm
r _{a max}	4 mm
r _{min}	5 mm
m	77,2 kg / Weight
C _r	2220000 N / Dynamic load rating (radial)
e	0,34
Y ₁	1,96
Y ₂	2,92
C _{0r}	2650000 N / Static load rating (radial)
Y ₀	1,92



DRIVESHAFT AND BEARINGS MANUFATURE C...

n_G	1940 1/min / Limiting speed
n_B	1180 1/min
C_{ur}	207000 N / Fatigue limit load, radial